

Blindtrack Services
Suite A2, Kebbell House
Delta Gain
Carpenters Park
Hertfordshire
WD19 5EF
Telephone: 0871 288 4911
Fax: 0871 288 4910
www.blindtrack.co.uk

Hand Operated Curtain Track Systems



Blindtrack Services
Suite A2, Kebbell House
Delta Gain
Carpenders Park
Hertfordshire
WD19 5EF
Telephone: 0871 288 4911
Fax: 0871 288 4910
www.blindtrack.co.uk



Hand Operated Curtain Track System

Silent Gliss® 1021

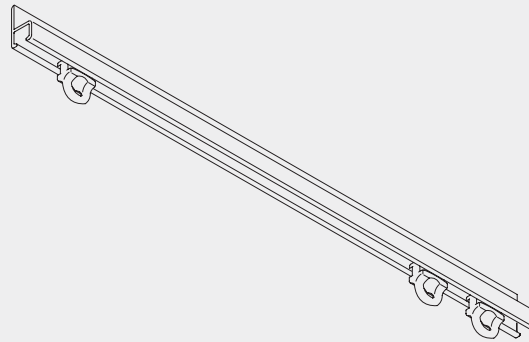

Product Information

- Discreet wall fix hand operated curtain track for light curtains and nets.
- Widely used for aircraft, trucks, boats, caravans, etc..
- Ideal for mounting directly on to window frames/doors or wooden batten.
- Pre-drilled every 300mm.
- Standard colours: silver, white, bronze and gold.
- Standard profile lengths: 5m silver only, 6m all colours.
- Can be bent.



1021

Profile, Bending and Specification Information

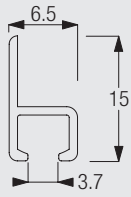

1021



Can be bent.
 Std. radius R 1021 = 100mm

The standard radius is recommended for optimal operation. The minimum possible radius is 60mm.

Specification Guide - download from Silent Gliss Extranet

Silent Gliss 1021 curtain track, hand-drawn, anodised aluminium, complete with gliders 3533 at 16/m. and 2 stops 3016 per length, face fixed level with under-side timber batten (by others) at 300mm. centres with special screw 6835.Lm.

Fitting Information

Fixing points



The fixing distances are meant as a guide only: they may vary in practice depending on surface and curtain weight.

Fitting Options

Face fix profile



1021

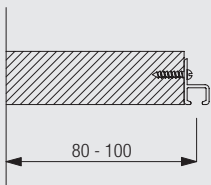

Fixing profile underneath

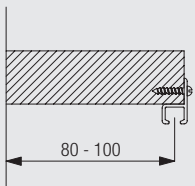

The final distances may be outside of the recommendations above depending on curtain heading, make-up and any obstructions. Batten thickness depends on length of screw.

Standard Accessories

1021

Profile



3016

Endstop



3534 Glider 3533 in strip form

Special roundhead screw 12mm
 No. 4

Optional Accessories

3017	Endstop		3032	Spring stop	
3070	Twist eye endstop		3071	Screw twist endstop	
3511	Glider		3533	Glider	
3548	Retrofit glider		3570	Rotating glider	
3580	Side mounted glider/hook		4092	Plastic draw rod (4092S Aluminium)	
6835B	Special roundhead screw 24mm No.4		6835C	Pozidrive screw 12mm No.4	

Useful Information and Sewing Accessories

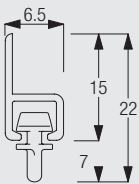







Diagram uses standard 3533/3534 glider and is measured to the inside of the glider eye. For optional gliders substitute dimensions below:
 3570 = 6.0mm
 3548 = 7.5mm



1021

3068	Loop tape		3562	Standard tape	
3571	Hook		3582	Hook	
3599	Hook				

Blindtrack Services
Suite A2, Kebbell House
Delta Gain
Carpenders Park
Hertfordshire
WD19 5EF
Telephone: 0871 288 4911
Fax: 0871 288 4910
www.blindtrack.co.uk



1021

Blindtrack Services
Suite A2, Kebbell House
Delta Gain
Carpenders Park
Hertfordshire
WD19 5EF
Telephone: 0871 288 4911
Fax: 0871 288 4910
www.blindtrack.co.uk



1021

Blindtrack Services
Suite A2, Kebbell House
Delta Gain
Carpenders Park
Hertfordshire
WD19 5EF
Telephone: 0871 288 4911
Fax: 0871 288 4910
www.blindtrack.co.uk

www.silentgliss.co.uk

Silent Gliss Ltd
Pyramid Business Park
Poorhole Lane
Broadstairs
Kent
CT10 2PT
Great Britain

Tel: 0044 (0) 1843 863571
Fax: 0044 (0) 1843 864503
sales@silentgliss.co.uk